

Dimensões em polegada
Dimensions in inches

THIS IS AN UPDATED REVISION, THE
PREVIOUS ONE MUST BE DISREGARDED.

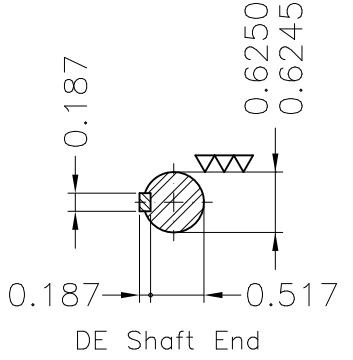
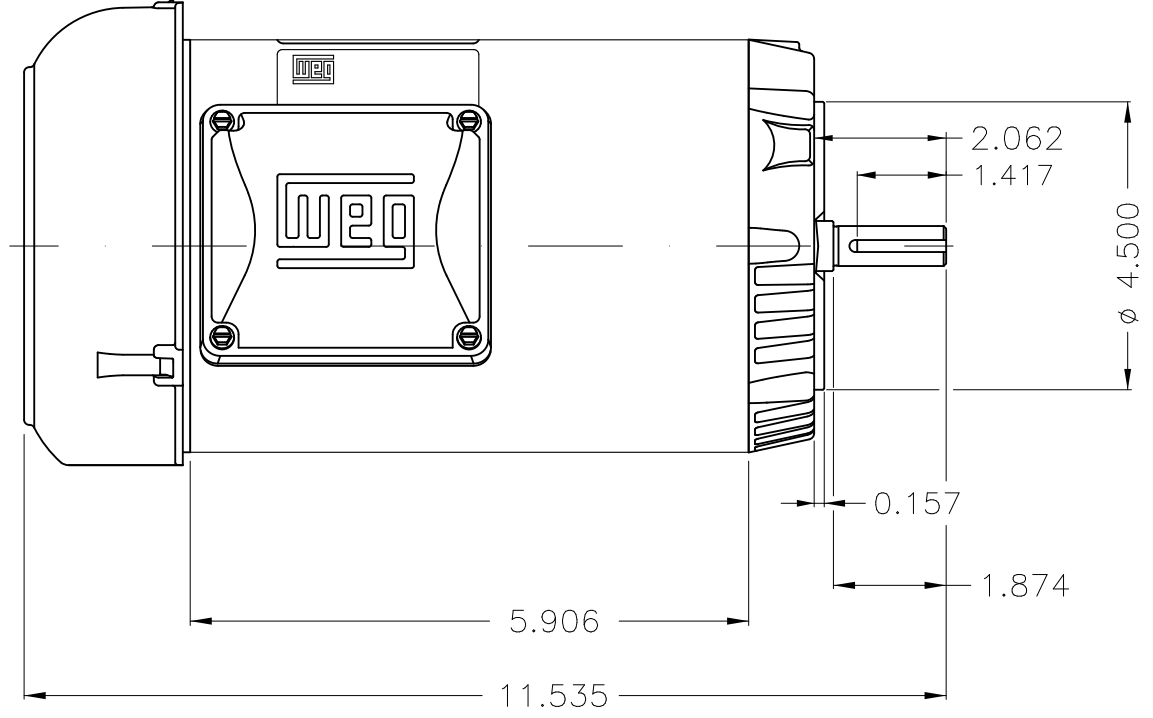
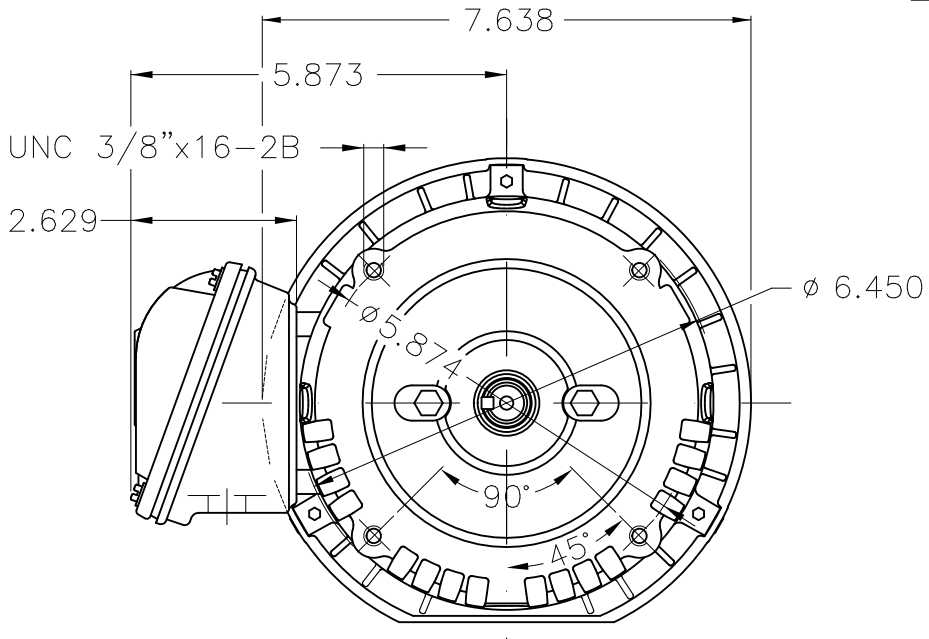
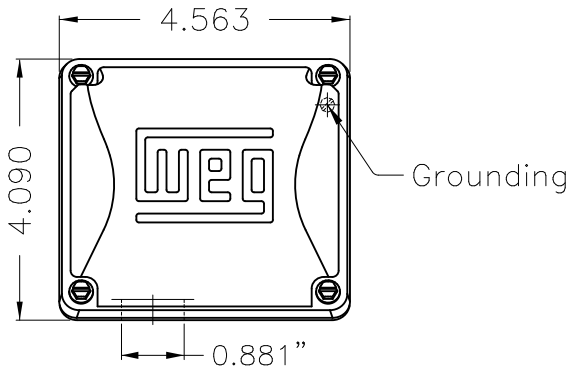

Color Munsell N 1 matte black
Painting plan 207N
Mounting F-1/B14R(D)

ECM	LOC	SUMMARY OF MODIFICATIONS	EXECUTED	CHECKED	RELEASED	DATE	VER
EXECUTED	USERADMIN	THREE PHASE MOTOR TEFC ROLLED STEEL					
CHECKED		FRAME 56C IP55 TEFC					
RELEASED		WEG code: 12894828					
REL DT	23.01.2018	WMO Jaragua do Sul	Product Engineering	SHEET	1 / 1		

0.75 HP 02 Poles 60Hz

