

Dimensões em polegada
Dimensions in inches

THIS IS AN UPDATED REVISION, THE
PREVIOUS ONE MUST BE DISREGARDED.

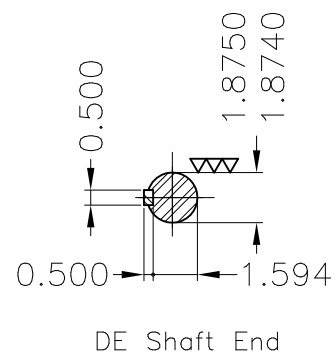
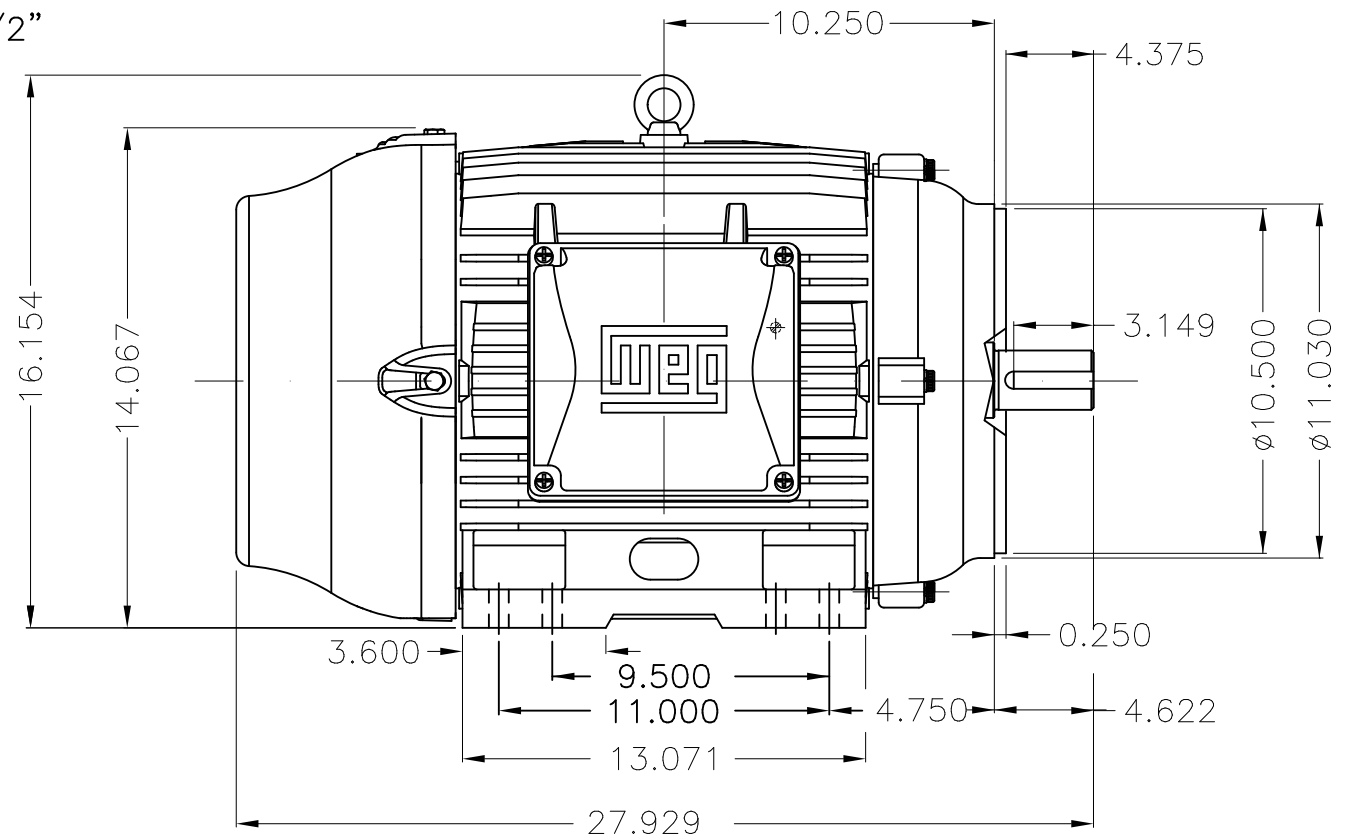
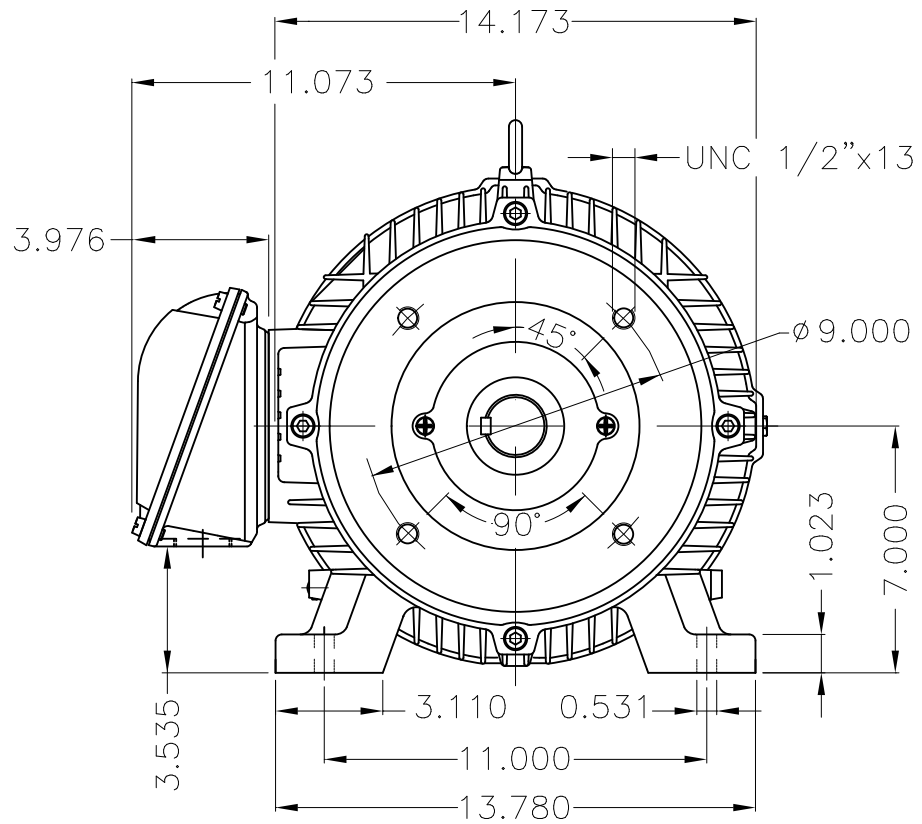
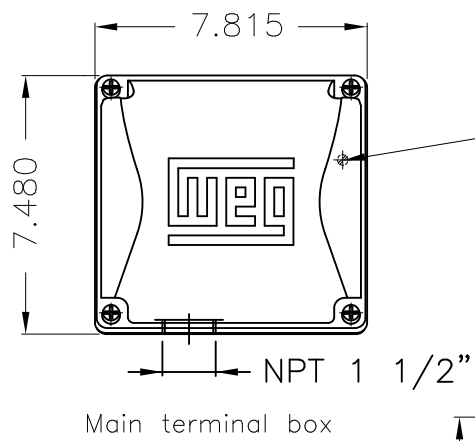
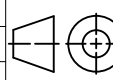

Color RAL 5009
Painting plan 203A
Mounting B34R(D)

ECM	LOC	SUMMARY OF MODIFICATIONS			EXECUTED	CHECKED	RELEASED	DATE	VER
EXECUTED	USERADMIN	 THREE PHASE W22 MOTOR - NEMA PREMIUM EFF FRAME 284/6TC IP55 TEFC WEG code: 11580967							
CHECKED									
RELEASED									
REL DT	24.01.2018	WMO	Jaragua do Sul	Product Engineering	SHEET	1 / 1			

20 HP 06 Poles 60Hz

