

Dimensões em polegada
Dimensions in inches

THIS IS AN UPDATED REVISION, THE
PREVIOUS ONE MUST BE DISREGARDED.

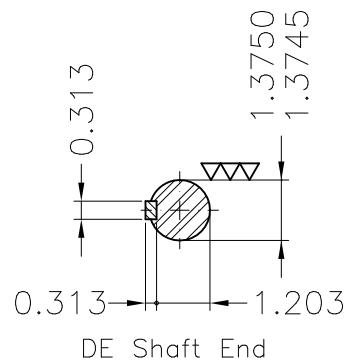
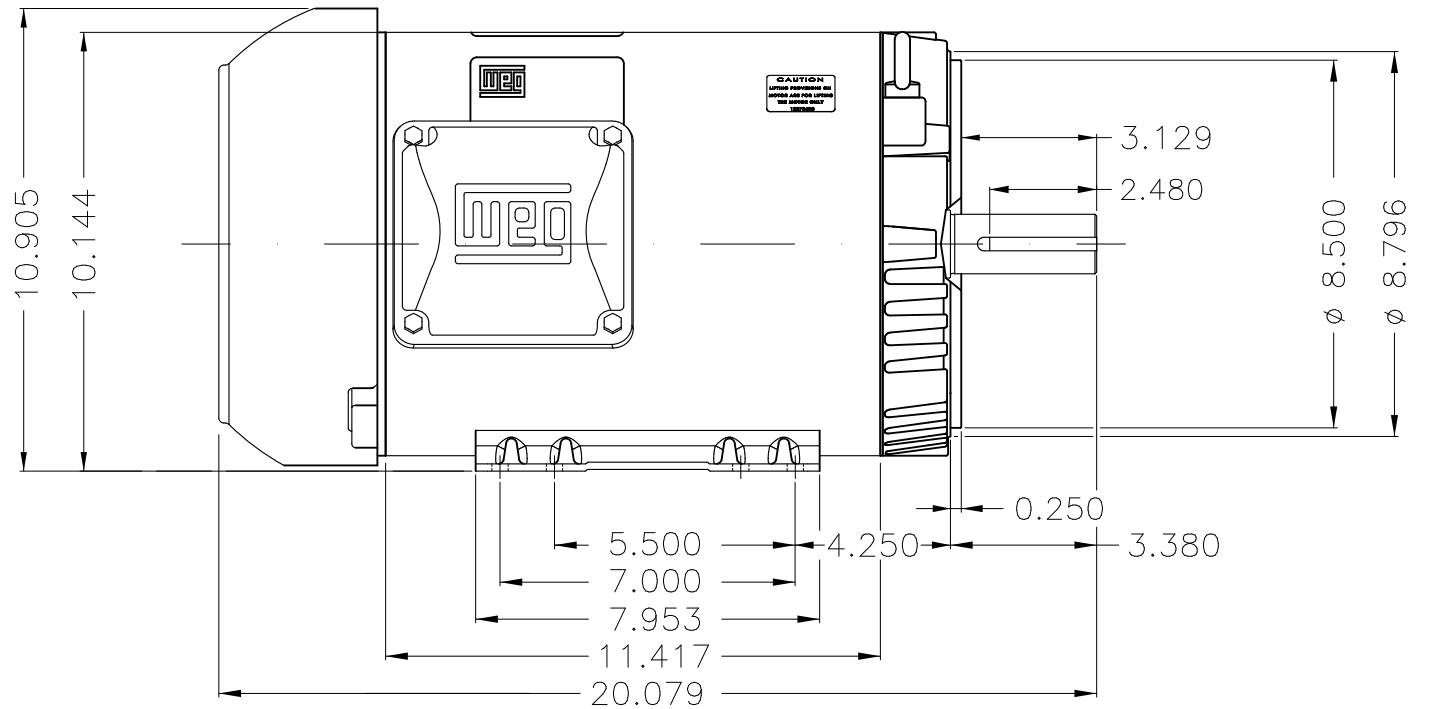
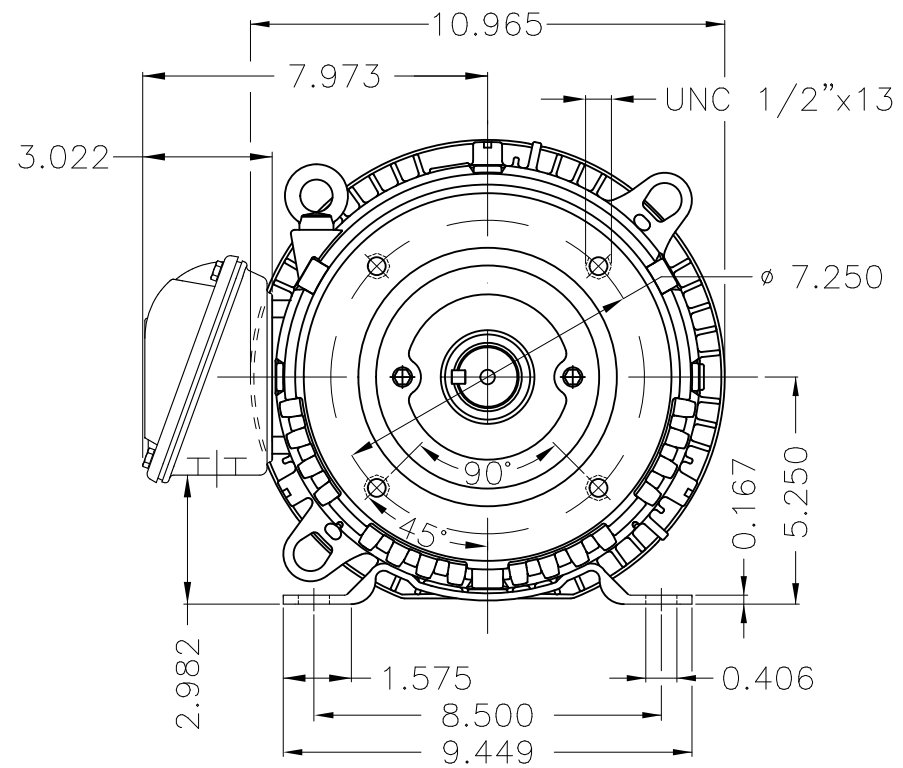
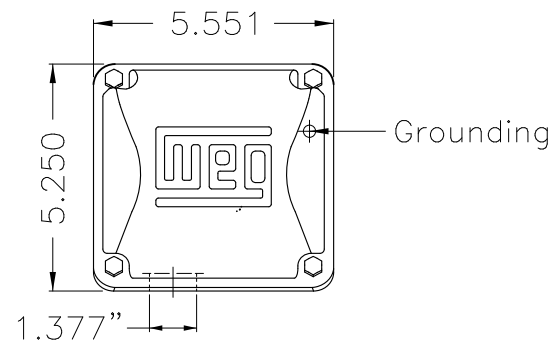
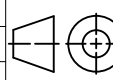

Color Munsell N 1 matte black
Painting plan 207N
Mounting F-1/B34R(D)

ECM	LOC	SUMMARY OF MODIFICATIONS	EXECUTED	CHECKED	RELEASED	DATE	VER
EXECUTED	USERADMIN	 THREE P. MOTOR TEFC ROLLED STEEL NEMA P. FRAME 213/5TC IP55 TEFC WEG code: 12675355					
CHECKED							
RELEASED							
REL DT	24.01.2018	WMO Jaragua do Sul	Product Engineering	SHEET	1 / 1		

7.5 HP 02 Poles 60Hz

A

