

Dimensões em polegada
Dimensions in inches

THIS IS AN UPDATED REVISION, THE
PREVIOUS ONE MUST BE DISREGARDED.

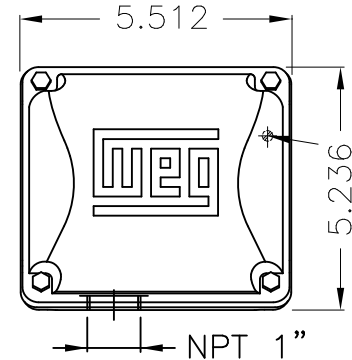
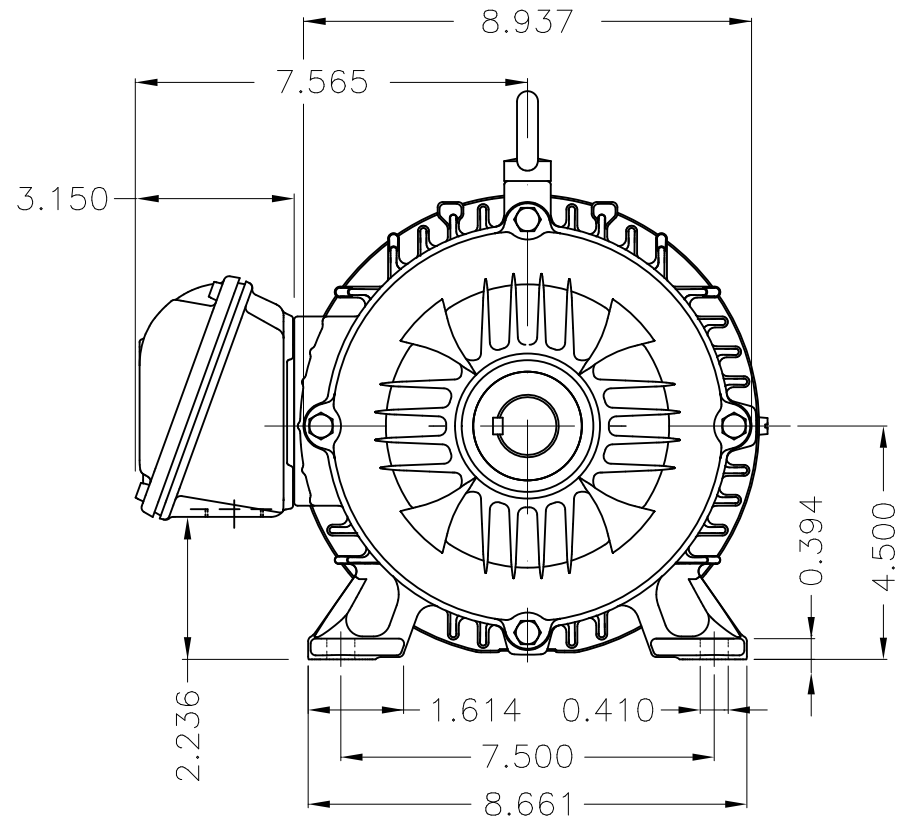

Main terminal box

Grounding for leads 2-10 mm² / 14-7 AWG

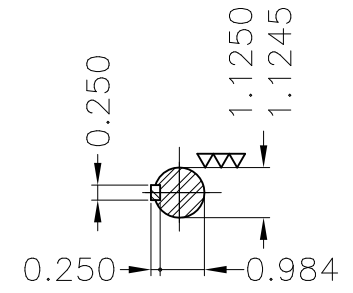
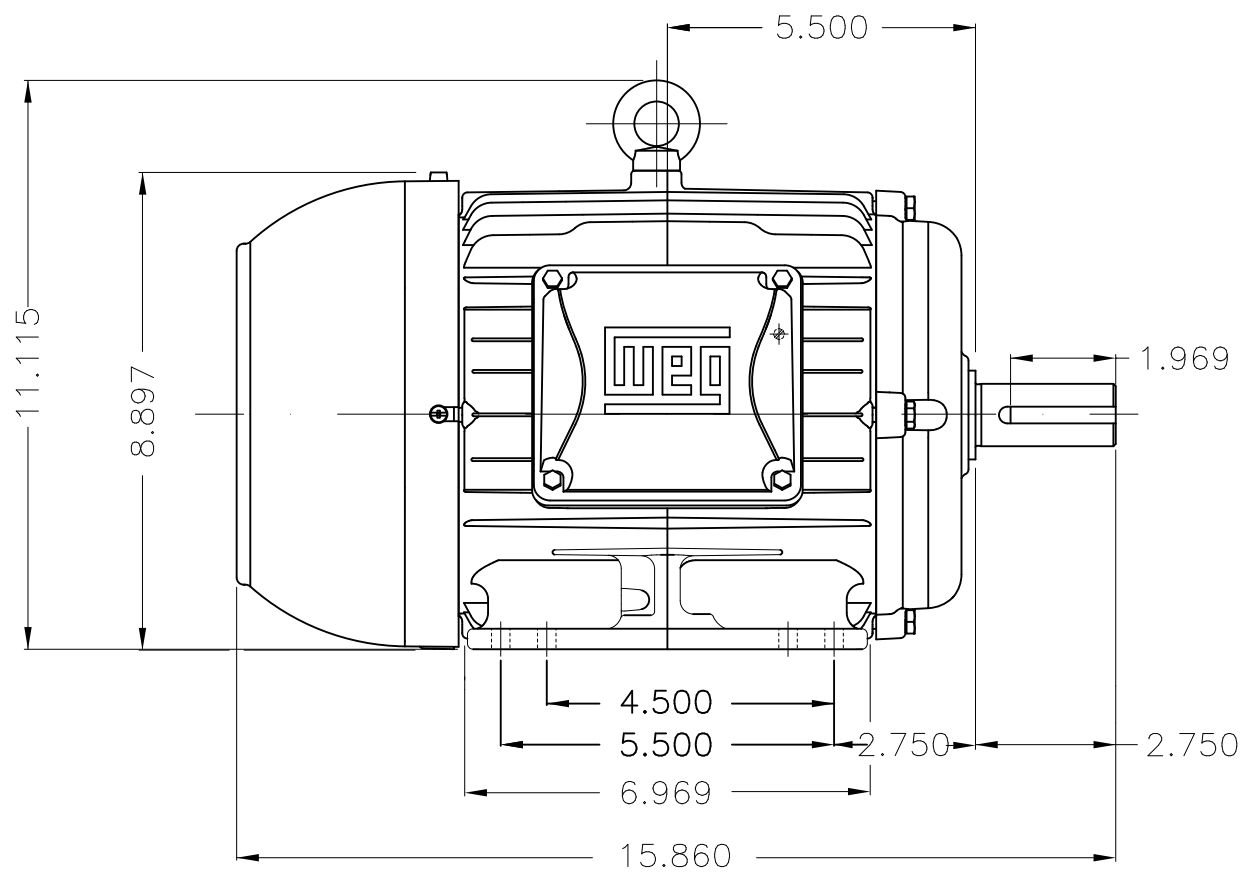

DE Shaft End

Color RAL 5009
Painting plan 207A
Mounting B3R(D)

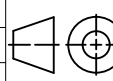
ECM	LOC	SUMMARY OF MODIFICATIONS			EXECUTED	CHECKED	RELEASED	DATE	VER
EXECUTED	USERADMIN		THREE PHASE W22 MOTOR - NEMA PREMIUM EFF						
CHECKED			FRAME 182/4T IP55 TEFC						
RELEASED			WEG code: 11457580						
REL DT	27.01.2018	WMO	Jaragua do Sul	Product Engineering	SHEET	1 / 1			

5 HP 02 Poles 60Hz

A



ZME A3