

DESIGN LOAD REPORT

Part Description: P4045 (2-Hole, Z-Shaped Fitting)

Report Date: August 8, 2022

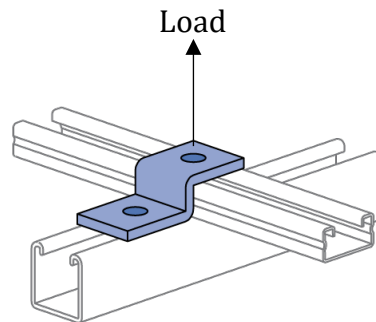

Allowed Load (lbs)
400

NOTES

1. Design loads only apply to Unistrut brand products. Look for "UNISTRUT" on the part
2. Safety factor = 2.5 based on ultimate strength of connection.
3. Load data is based on a P1010 nut and ½" bolt in 12 ga. channel.

Unistrut Engineering