

BALDOR® • **RELIANCE**

Product Information Packet

GMP3342

.5HP, 1725RPM, 3PH, 60HZ, PSLH, 3320M, TEFC,

Part Detail							
Revision:	H	Status:	PRD/A	Change #:		Proprietary:	No
Type:	AC	Elec. Spec:	33WG0673	CD Diagram:	CD0005A05	Mfg Plant:	
Mech. Spec:		Layout:	33E887-0673G2	Poles:	04	Created Date:	11-05-2015
Base:		Eff. Date:	04-18-2017	Leads:	9#18		

Specs			
Catalog Number:	GMP3342		
Enclosure:	TEFC		
Frame Material:	Steel		
Output @ Frequency:	.500 HP @ 60 HZ		
Synchronous Speed @ Frequency:	1800 RPM @ 60 HZ		
Voltage @ Frequency:	460.0 V @ 60 HZ		
	230.0 V @ 60 HZ		
	208.0 V @ 60 HZ		
Agency Approvals:	CSA		
	UR		
Current @ Voltage:	1.300 A @ 460.0 V		
	2.300 A @ 208.0 V		
	2.600 A @ 208.0 V		
	2.600 A @ 230.0 V		
Design Code:	B		
Duty Rating:	CONT		
Feedback Signal:	NONE		
Heater Indicator:	No Heater		

Insulation Class:	F		
Inverter Code:	Not Inverter		
KVA Code:	-		
Motor Lead Quantity/Wire Size:	9 @ 18 AWG		
Motor Type:	3320M		
Power Factor:	54		
Product Family:	General Purpose		
RoHS Status:	ROHS COMPLIANT		
Shaft Rotation:	Reversible		
Motor Standards:	NEMA		
Starting Method:	Full Voltage		
Thermal Device - Winding:	None		
Winding Thermal 1:	None		
Winding Thermal 2:	None		

Nameplate NP1220A07

CAT.NO.	GMP3342		
SER.NO			
SPEC.	33E887-0673G2		
HP	.5	TE	
VOLTS	208-230/460		
AMP	2.3-2.6/1.3		
HZ	60	PH	3
AMB.	40	DUTY	CONT
CAP		CODE	-
SER.F.	1.00	CLASS	F
R.P.M.	57.5		
TORQ/IN LB	484		
RATIO	30:1		
APRV-CSA		APRV-UL	

AC Induction Motor Performance Data

Record # 21905 - Typical performance - not guaranteed values

Winding: 33WG0673-R012	Type: 3320M	Enclosure: TEFC
-------------------------------	--------------------	------------------------

Nameplate Data				460 V, 60 Hz: High Voltage Connection	
Rated Output (HP)	.5			Full Load Torque	291.2 OZ-IN
Volts	460			Start Configuration	direct on line
Full Load Amps	1.2			Breakdown Torque	1400 OZ-IN
R.P.M.	1725			Pull-up Torque	1190 OZ-IN
Hz	60	Phase	3	Locked-rotor Torque	1190 OZ-IN
NEMA Design Code	B	KVA Code	-	Starting Current	6.1 A
Service Factor (S.F.)	1			No-load Current	1.2 A
NEMA Nom. Eff.	71	Power Factor	54	Line-line Res. @ 25°C	28.9 Ω
Rating - Duty	40C AMB-CONT			Temp. Rise @ Rated Load	
				Locked-rotor Power Factor	69
				Rotor inertia	43.1 LB-FT ²

Load Characteristics 460 V, 60 Hz, 0.5 HP

% of Rated Load	25	50	75	100	125	150
Power Factor	23	32	41	50	57	63
Efficiency	43.2	59.5	67.4	71.4	73.4	74
Speed	1782	1769	1752	1734	1717	1695
Line amperes	1.2	1.22	1.26	1.32	1.4	1.5

Performance Graph at 460V, 60Hz, 0.5HP Typical performance - Not guaranteed values

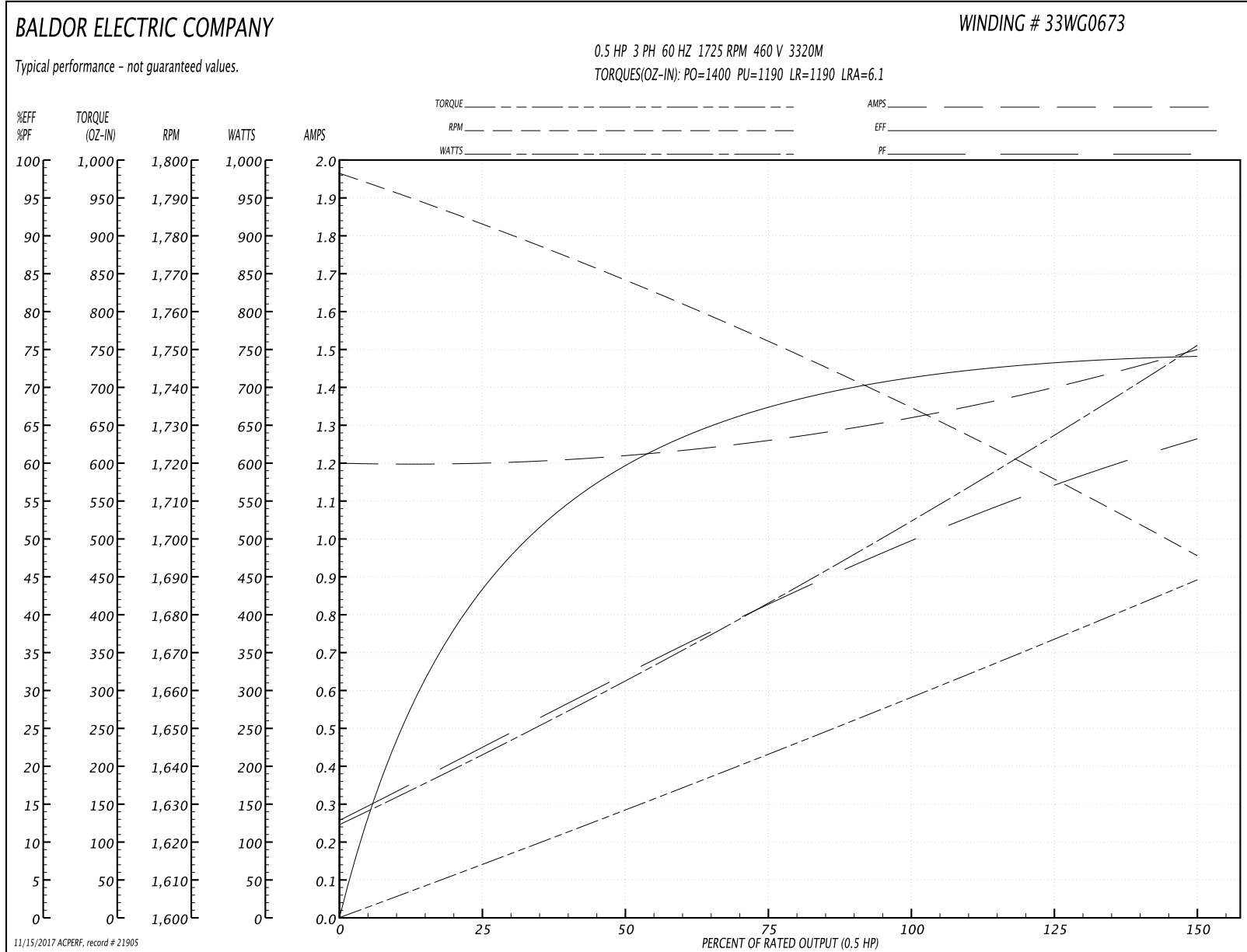

AC Induction Motor Performance Data

Record # 21907 - Typical performance - not guaranteed values

Winding: 33WG0673-R012	Type: 3320M	Enclosure: TEFC
-------------------------------	--------------------	------------------------

Nameplate Data				230 V, 60 Hz: Low Voltage Connection	
Rated Output (HP)	.5			Full Load Torque	290.6 OZ-IN
Volts	230			Start Configuration	direct on line
Full Load Amps	2.4			Breakdown Torque	1400 OZ-IN
R.P.M.	1725			Pull-up Torque	1190 OZ-IN
Hz	60	Phase	3	Locked-rotor Torque	1190 OZ-IN
NEMA Design Code	B	KVA Code	-	Starting Current	12.3 A
Service Factor (S.F.)	1			No-load Current	2.41 A
NEMA Nom. Eff.	71	Power Factor	54	Line-line Res. @ 25°C	7.4 Ω
Rating - Duty	40C AMB-CONT			Temp. Rise @ Rated Load	

Load Characteristics 230 V, 60 Hz, 0.5 HP

% of Rated Load	25	50	75	100	125	150
Power Factor	23	32	41	50	57	63
Efficiency	43.1	59.4	67.2	71.4	73.4	73.8
Speed	1785	1768	1752	1735	1717	1695
Line amperes	2.4	2.44	2.52	2.63	2.79	3

Performance Graph at 230V, 60Hz, 0.5HP Typical performance - Not guaranteed values

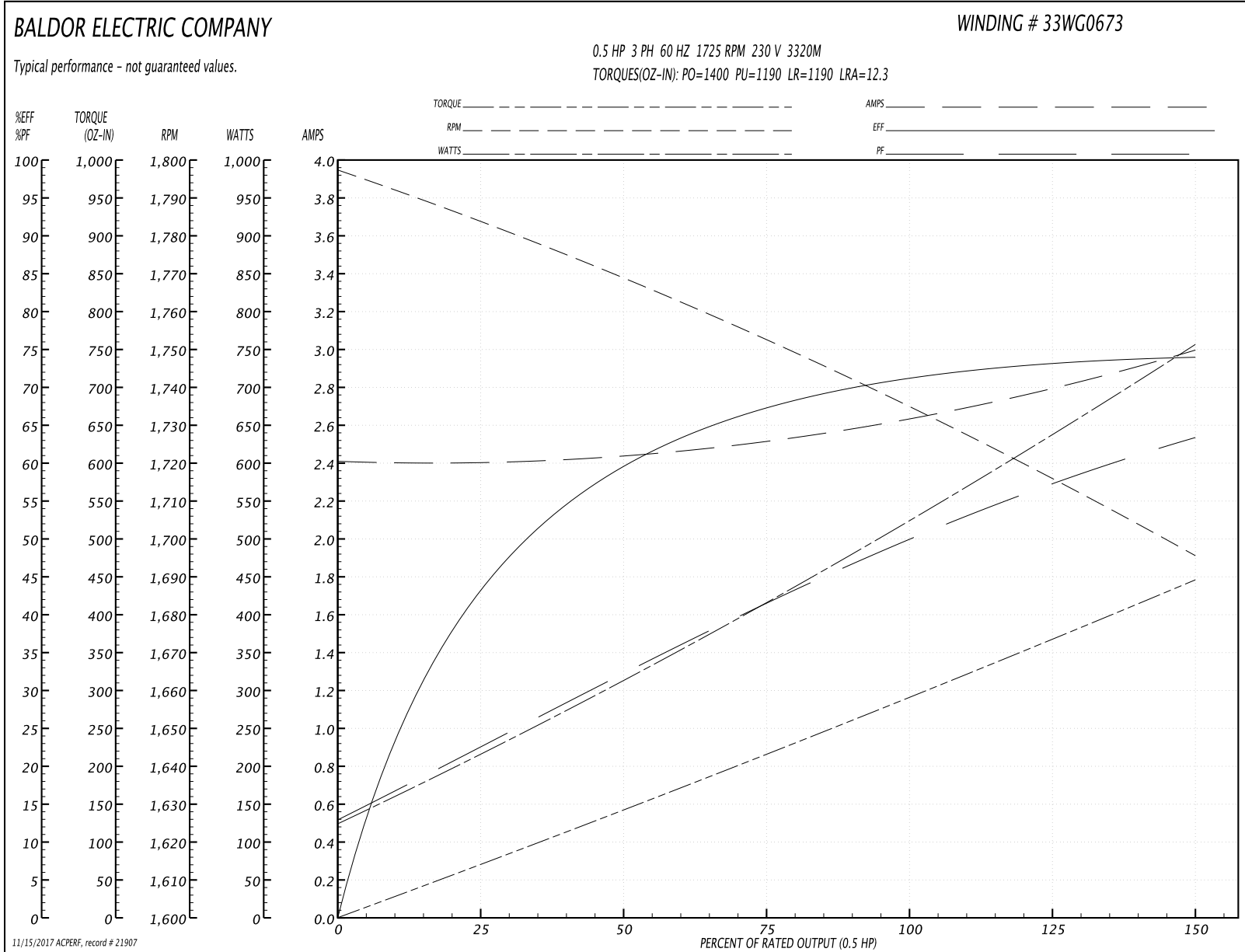

AC Induction Motor Performance Data

Record # 21908 - Typical performance - not guaranteed values

Winding: 33WG0673-R012	Type: 3320M	Enclosure: TEFC
-------------------------------	--------------------	------------------------

Nameplate Data				208 V, 60 Hz: Low Voltage Connection	
Rated Output (HP)	.5			Full Load Torque	293.1 OZ-IN
Volts	208			Start Configuration	direct on line
Full Load Amps	2.6			Breakdown Torque	1400 OZ-IN
R.P.M.	1725			Pull-up Torque	1190 OZ-IN
Hz	60	Phase	3	Locked-rotor Torque	1190 OZ-IN
NEMA Design Code	B	KVA Code	-	Starting Current	10.96 A
Service Factor (S.F.)	1			No-load Current	1.87 A
NEMA Nom. Eff.	71	Power Factor	54	Line-line Res. @ 25°C	28.9 Ω
Rating - Duty	40C AMB-CONT			Temp. Rise @ Rated Load	

Load Characteristics 208 V, 60 Hz, 0.5 HP

% of Rated Load	25	50	75	100	125	150
Power Factor	26	39	50	60	67	73
Efficiency	52.1	66.9	72.7	75	75.2	74.2
Speed	1780	1762	1743	1721	1694	1664
Line amperes	1.9	1.98	2.12	2.32	2.57	2.88

Performance Graph at 208V, 60Hz, 0.5HP Typical performance - Not guaranteed values

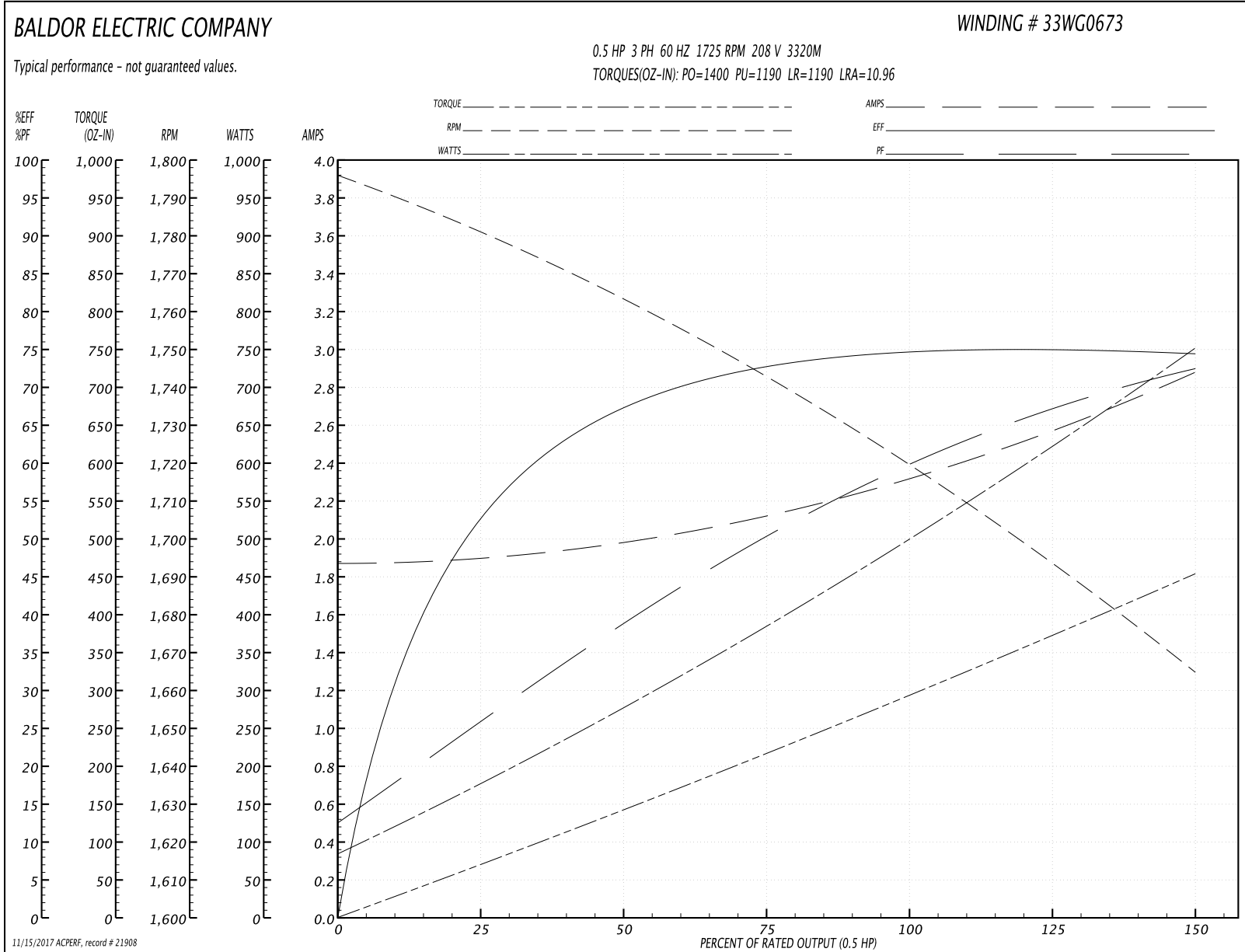

11/15/2017 ACPERF, record # 21908

33E887-0673G2

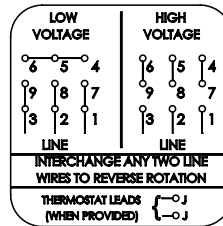
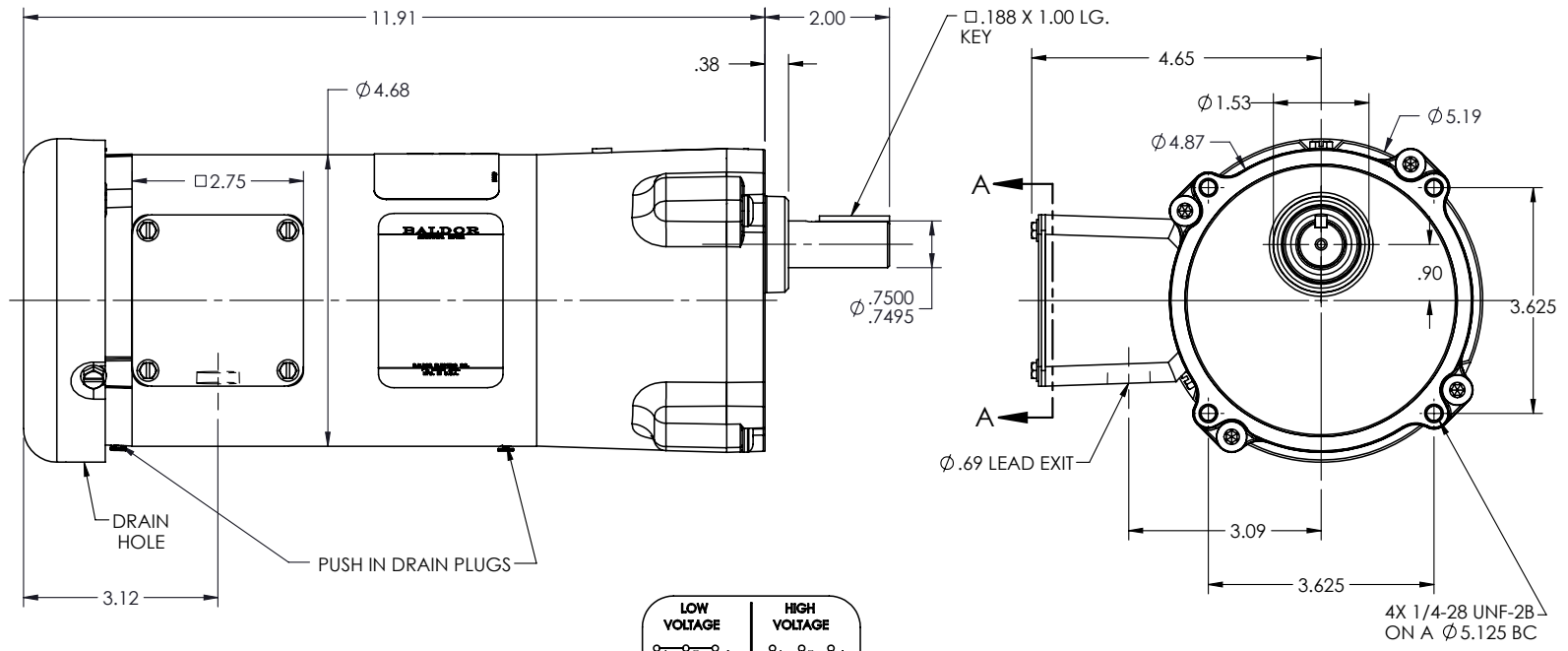

SECTION A-A

CUSTOMER IS RESPONSIBLE FOR DETERMINING THAT BALDOR'S PRODUCT WILL PERFORM SUITABLY IN THE INTENDED APPLICATION

REV. DESC: NEW			
REV: -	VERSION: 00	REVISED: 09:40:19 11/13/2015	TDR: 000000951888
33E887-0673G2		MODEL NO. 33E887-0673G2	REF:
		BY: CKYUKP0	

BALDOR

LY,33AC PSL RSB TEFC 2.00 X 0.75 KEY

33E887-0673G2

33E887-0673G2

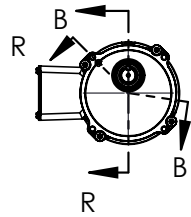

SECTION R-R

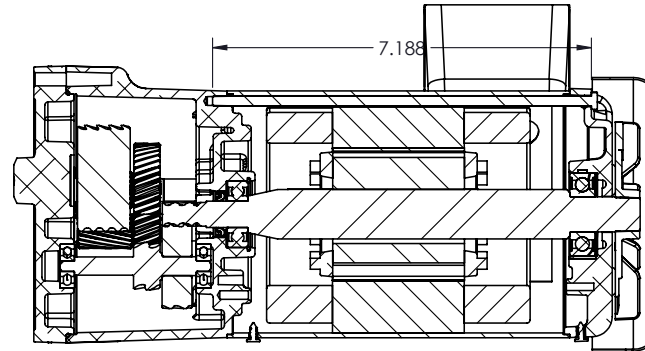

SECTION B-B

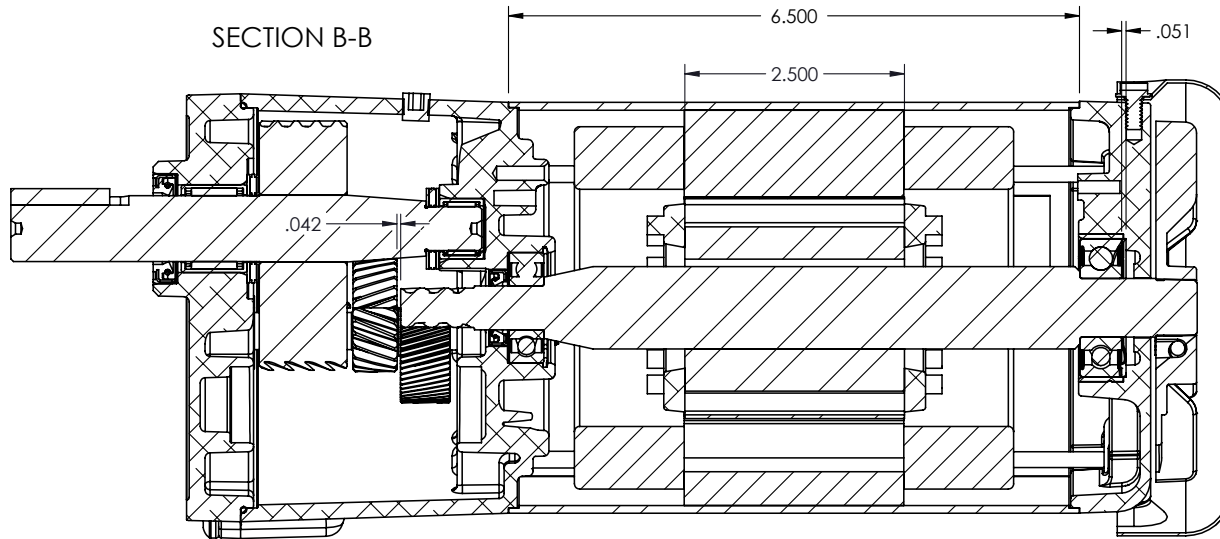

CUSTOMER IS RESPONSIBLE FOR DETERMINING THAT BALDOR'S PRODUCT WILL PERFORM SUITABLY IN THE INTENDED APPLICATION

REV. DESC: NEW			
REV: -	VERSION: 00	REVISED: 09:40:19 11/13/2015	TDR: 000000951888
33E887-0673G2	MODEL NO. 33E887-0673G2		REF:
	BY: CKYUKP0		

BALDOR

LY,33AC PSL RSB TEFC 2.00 X 0.75 KEY

33E887-0673G2

ITEM NO.	PART NUMBER	QTY.
1	HG0076A16	1
2	BMH1714	2
3	BH1165A02	1
4	HW5002A95	1
5	HW4600D35	1
6	BH1163A02	1
7	HA4021A05	1
8	HW3064E05	1
9	33SH7271B01	1
10	33RC4120-00	1
11	BG6203C03	1
12	33SA9200B96	1
13	NS2512A01	1
14	34GS1029A01	1
15	34CB3002C	1
16	51XB1016A07	2
17	11XT1032G06	1
18	34CB4517	1
19	34GS1031A01	1
20	51XT0832A07	4
21	33EP3100A01	1
22	HW5109A05	1
23	HA3100A	2
24	33FN3000	1
25	12XN0832A16	1
26	HW1003A08	1
27	XY0832A02	1
28	33FH4000A01	1
29	51XB1016A06	3
30	SG0045C11	1
31	SG0045C12	1
32	SG0045C13	1
33	CG0012A01	1
34	RM1020A22	1
35	BH1163A03	1
36	HW4600D39	1
37	60XM2520A12	4
38	LC0005	1
39	LB1119	1
40	BMH1910	1
41	HA4067	2
42	NP1220A 33AC RSB	1

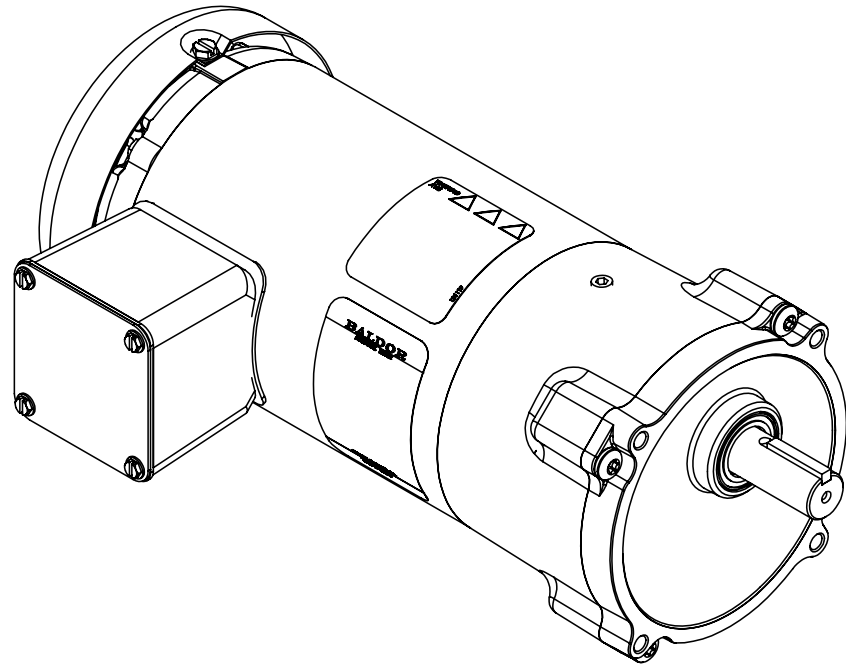

33E887-0673G2

33E887-0673G2

CUSTOMER IS RESPONSIBLE FOR DETERMINING THAT BALDOR'S PRODUCT WILL PERFORM SUITABLY IN THE INTENDED APPLICATION

REV. DESC: NEW			
REV: -	VERSION: 00	REVISED: 09:40:19 11/13/2015	TDR: 000000951888
33E887-0673G2		MODEL NO. 33E887-0673G2	REF:
		BY: CKYUKP0	

BALDOR

LY,33AC PSL RSB TEFC 2.00 X 0.75 KEY

CD0005A05

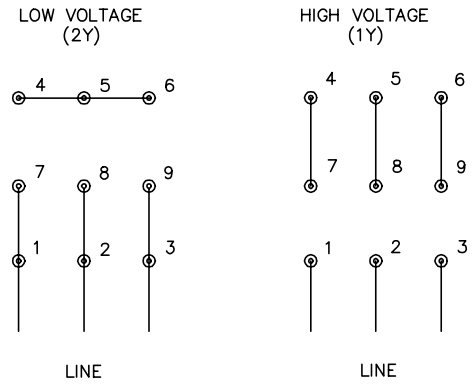
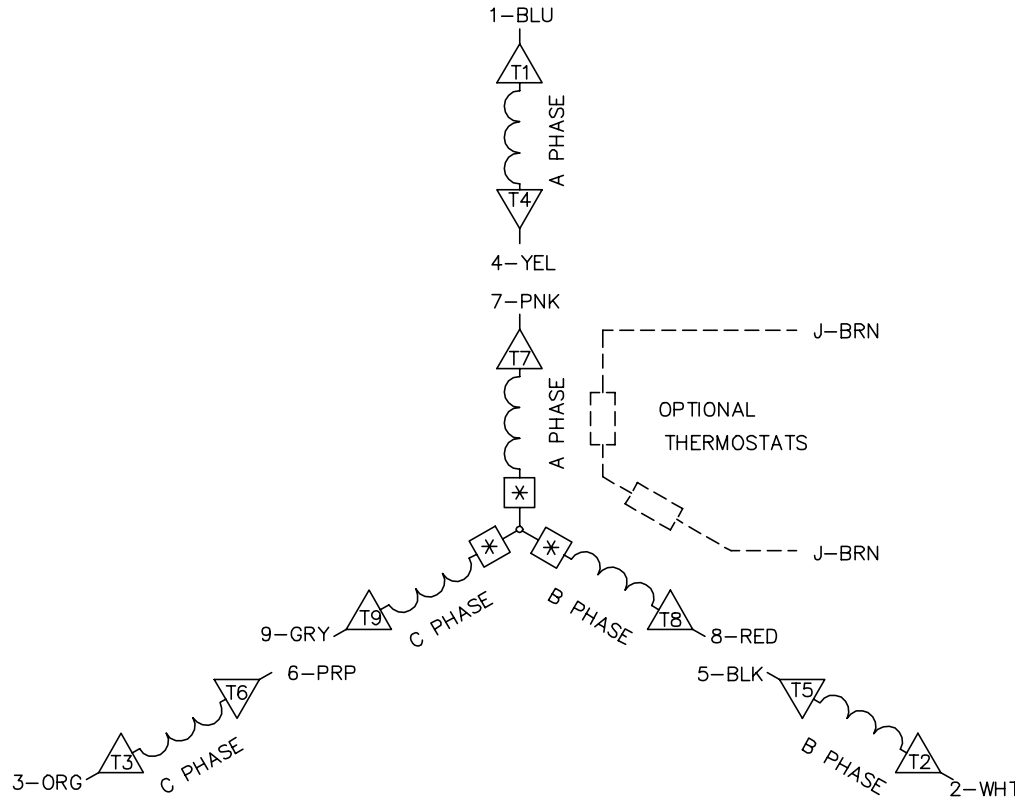

- NOTES:
1. INTERCHANGE ANY TWO LINE LEADS TO REVERSE ROTATION.
 2. OPTIONAL THERMOSTATS ARE PROVIDED WHEN SPECIFIED.
 3. ACTUAL NUMBER OF INTERNAL PARALLEL CIRCUITS MAY BE A MULTIPLE OF THOSE SHOWN ABOVE.
 4. LEAD COLORS ARE OPTIONAL. LEADS MUST ALWAYS BE NUMBERED AS SHOWN.
 5. =MAGNET WIRE COIL END WITH I.D. NUMBER.
 6. =MAGNET WIRE COIL END WITH I.D. SYMBOL.
 7. SEE CW PRINT FOR NEST TO NEST CROSSOVER CONNECTIONS.

REV. DESC: ADD NEST NOTE			
REV. LTR: C	VERSION: 03	TDR: 000000445597	
CD0005A05	FILE: \CKA\00024\847	REVISED: 12:51:06 11/15/2007	
	MTL: -	BY: CKMICRO	

BALDOR • DODGE • RELIANCE

3PH, DV, 9 LEADS, CK

CD0005A05